

IMPACT ACOUSTIC®

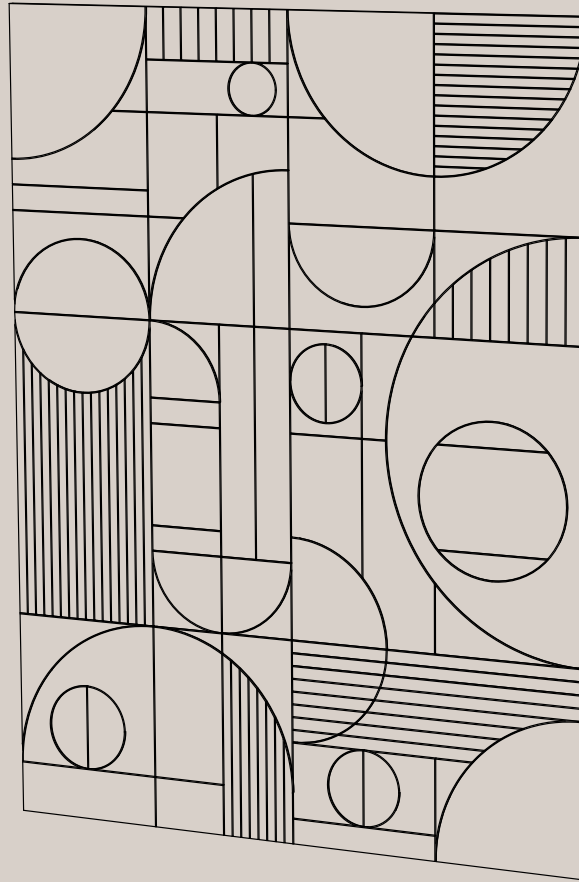

HABITAT
MATTER

habitatmatter.com
spec@habitatmatter.com



Bau

Wall Covering

732.24.27.000.00

732.12.27.000.00

TECHNICAL DATA SHEET



Bau

General Information

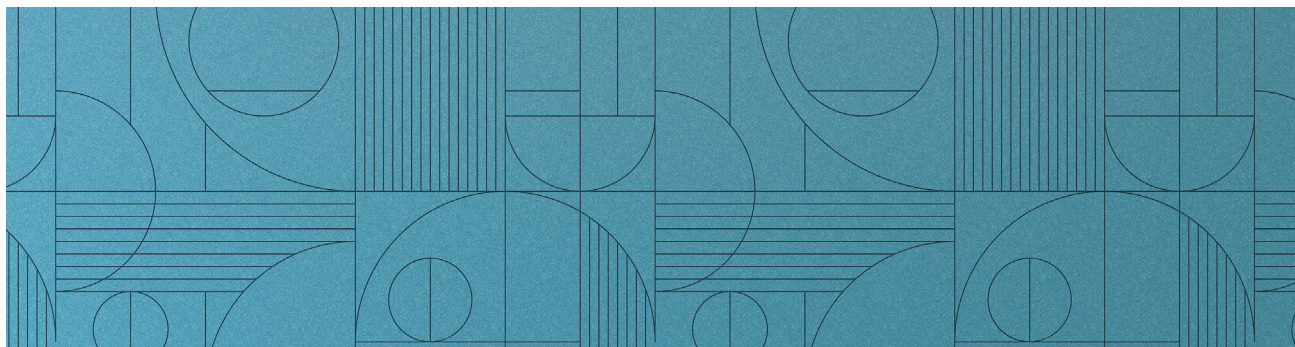

Data

Applicable article numbers

732.24.27.000.00

732.12.27.000.00

Total Dimensions³

	24mm / 12 mm	0.9" / 0.5"	
Height	2400mm / 2800mm	95" / 110"	 Custom solutions available
Weight	1800mm / 1200mm	71" / 47"	

Material

Wall Covering	100% PET (60% post-consumer) 32 colors	 Extended document available
Glue	Spray Glue	

Weight¹

24mm / 0.95"	4 kg/m ²	0.82 lbs/sq.ft
12mm / 0.47"	2.4 kg/m ²	0.49 lbs/sq.ft

Included

PET Panels



Spray glue



Installation
guide



Warranty
2 years²



1 - all weights are nominal

2 - Impact Acoustic warranty terms apply

3 - all dimensions are nominal



Bau

Specification Guide

1 Prepare this information:

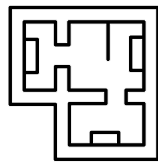

Project Area

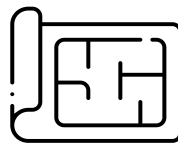

Plans



Other Considerations

2 Specify your Wall Covering:

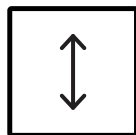

Material thickness

page 4-5

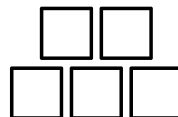

Quantity

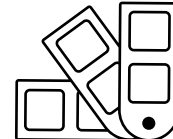

Colour

page 6

3 Article numbers:

732	Material Thickness ³	27	Colour	00
732	24mm	27	Choose colour as shown on p. 6	00
	12mm			

Example: 732.24.27.662.00

Wall Covering - Bau, 2400 x 1800 x 24mm, 662 - Poster Red incl. spray glue



Bau

Geometry Information

Applicable articles numbers

732.24.27.000.00

Scope of delivery

For each item you will receive a set of 2x PET panels (in the dimensions below), 1x spray adhesive can per set.

Applicable articles numbers

These panels are mounted with a contact spray adhesive. Instructions are available online.

Bau 24mm

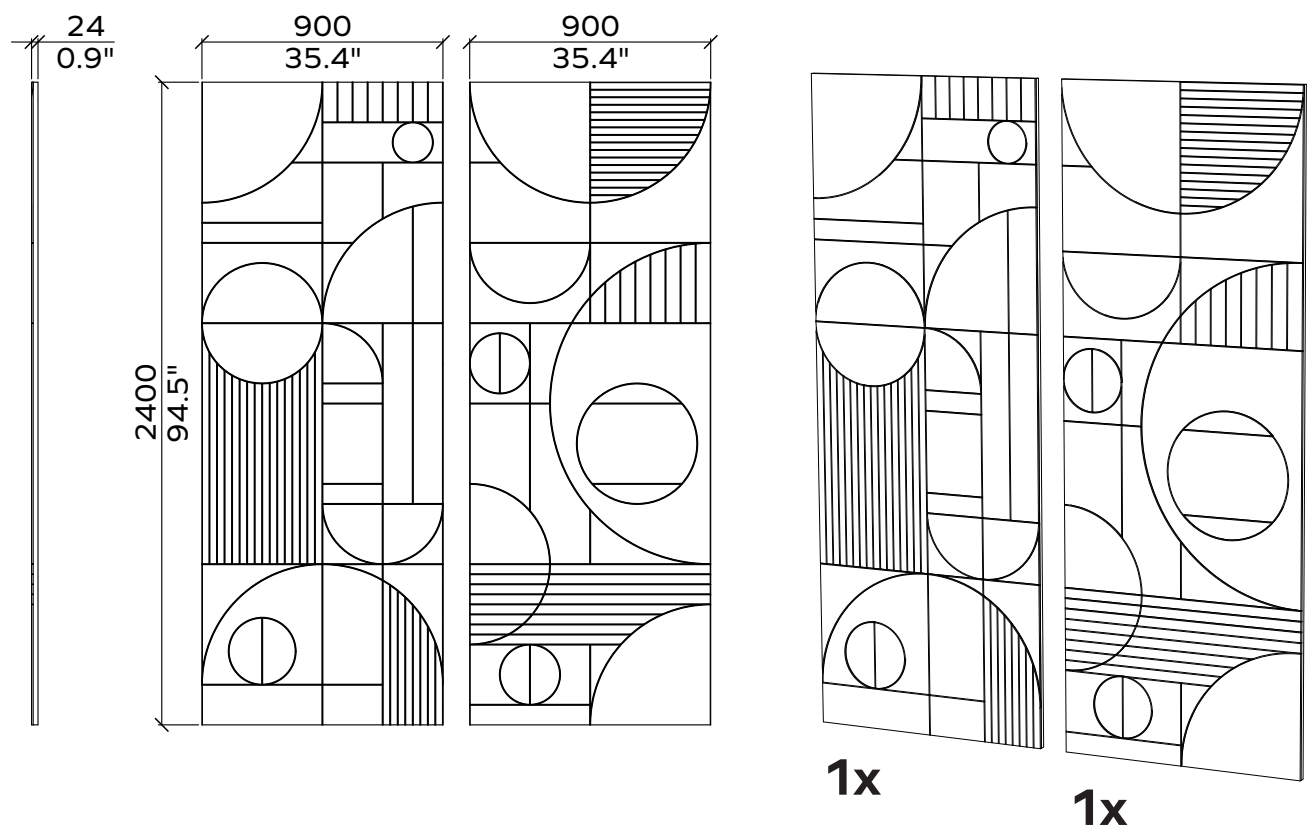
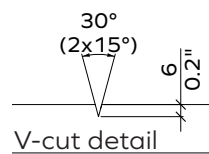

all dimensions are nominal



Bau

Geometry Information

Applicable articles numbers

732.12.27.000.00

Scope of delivery

For each item you will receive a set of 2x PET panels (in the dimensions below), 1x spray adhesive can per set.

Applicable articles numbers

These panels are mounted with a contact spray adhesive. Instructions are available online.

Bau 12mm

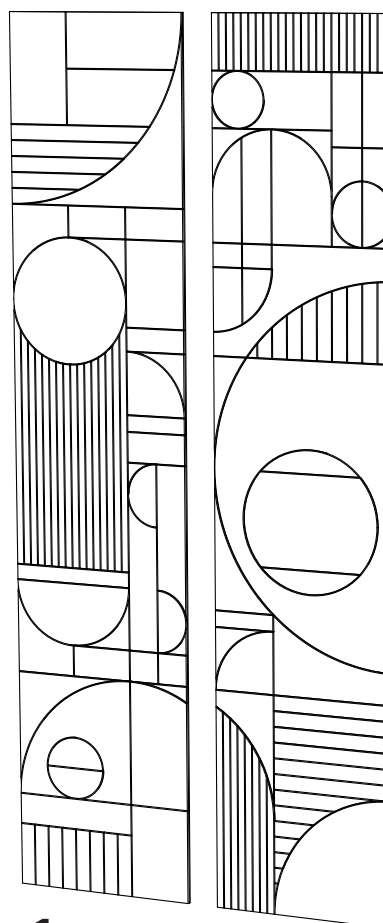
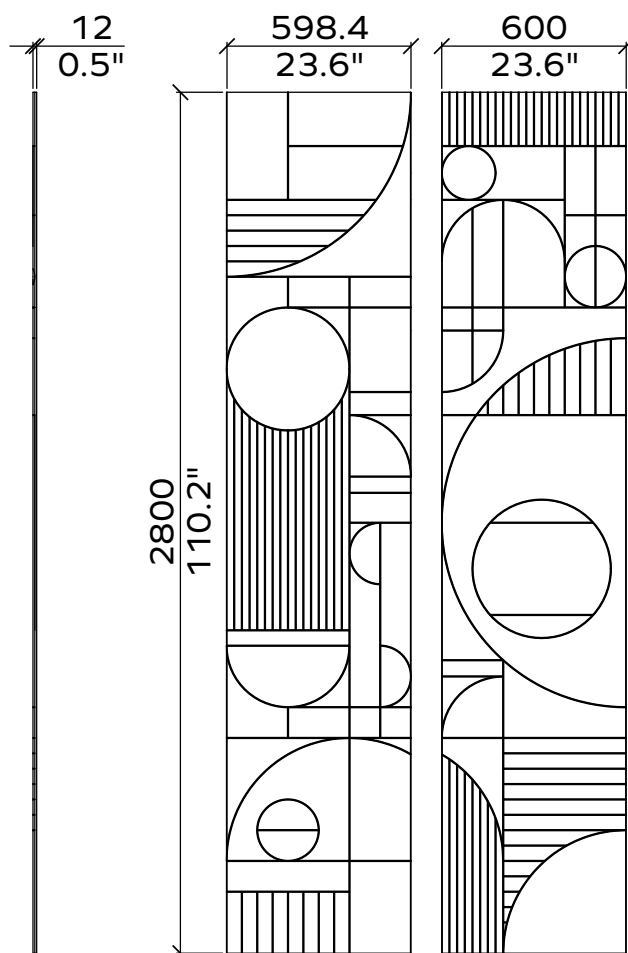
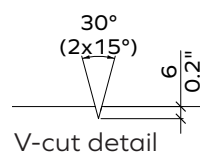

1x

1x

all dimensions are nominal

Colours



Name	Snow White	Milk	Cloud	Smoke	Ground	Charcoal	Slate	Raven
Color Code	500	404	103	442	108	542	444	550
NCS Code	S 0300-N	S 0502-Y	S 1002-B	S 3005-R80B	S 5005-Y20R	S 7502-B	S 4500-N	S 8500-N



Name	Nordic Pine	Grove	Moss	Spearmint	Ice Blue	Succulent	Deep Sea	Marine Blue
Color Code	311	317	439	706	304	712	918	864
NCS Code	S 5030-G10Y	S 7020-G30Y	S 2040-G40Y	S 1010-B90G	S 0510-B	S 3020-B30G	S 5020-R90B	S 4050-R70B



Name	Linen	Shell Pink	Jute	Warm Stone	Terracotta	Soft Coral	Honeycomb	Sunshine
Color Code	107	102	920	105	239	516	139	846
NCS Code	S 1505-Y30R	S 0510-R30B	S 3010-Y30R	S 3010-Y50R	S 4040-Y70R	S 2020-Y90R	S 2050-Y20R	S 1040-Y10R



Name	Garnet	Hot Pink	Poster Red	Electric Orange	Winter Sky	Pacific Ocean	Midnight	Grape
Color Code	724	140	662	464	311	311	810	540
NCS Code	S 5040-R10B	S 2060-R20B	S 1080-R	S 0580-Y70R	S 5030-G10Y	S 5030-G10Y	S 7020-R70B	S 5040-R40B

These NCS codes are the closest visual match available and may not be exact to blended fibres.

Colors

Experience our ARCHISONIC® Felt material with a stunning selection of 32 colors across 8 distinct families, thoughtfully curated by *Colour Hive* in London. Effortlessly combine colors harmoniously to suit your preferences. Discover more in our Materials brochure and order your free sample box today.

Color fastness

Class 6

ISO 105-B02:A1

Order a free sample box



ARCHISONIC®

Material Specification

Product Name	Archisonic® Felt	
Content	100% PET (60% certified post-consumer content)	
Thickness¹	12mm (0.47")	24mm (0.94")
Max. Size	1200x2800mm (47"x110")	1800x2400mm (70"x94")
Acoustic²	ASTM: NRC=0.6 ISO: αw=0.65	ASTM: NRC=0.9 ISO: αw=0.95
Density¹	2400 g/m ² (0.49 lbs/ sqft)	4000 g/m ² (0.82 lbs/sqft)
Color Fastness	Class 6 ISO 105-B02:A1	
Color	32 colors (see Archisonic® Felt Color page for more information)	
Maintenance	For daily cleaning we recommend alcohol solution (75%), e.g. Pantasept. In case of contamination by dust or fluff, use feather duster or a regular vacuum cleaner. For heavy dirt, treat the material with hydrogen peroxide.	
Lead time³	21 days	
Fire Rating	DIN EN 13501-1: B-s1, d0	ASTM E84 Class A
VOC Emission	A+ 28 Days French Regulation	ASTM E84 Pass
Certifications	Declare label, Cradle to Cradle, UL Environmental Product Declaration, Member of US Green Building Council, Ecobau 1st Priority, Climmate-KIC, VOC emissions in LEED EQ credit (low-emitting products), Bream, SCS Recycled Content	
Durability	Contract	

1 - all values are nominal 2 - measured with 300mm air cavity 3 - depending on the location and type of product



Climate-KIC is supported by the EIT, a body of the European Union



Declare.



Bau

Acoustic Performance

ISO Standards

ISO 354:2003	Acoustics — Measurement of sound absorption in a reverberation room
ISO 11654:1997	Acoustics — Sound absorbers for use in buildings — Rating of sound absorption
ISO 20189:2018	Acoustics — Screens, furniture and single objects intended for interior use — Rating of sound absorption and sound reduction of elements based on laboratory measurements

Equivalent ASTM Standards

ASTM C423-17	Standard Test Method for Sound Absorption and Sound Absorption Coefficients by the Reverberation Room Method
ASTM E795-16	Standard Practices for Mounting Test Specimens During Sound Absorption Tests

Acoustic Test Results ISO

Frequency (Hz)		125	250	500	1000	2000	4000	α_w
Archisonic 12mm (no air gap)	m ²	0.05	0.05	0.25	0.55	0.85	1.05	0.30 (MH)
Archisonic 12mm (50mm air gap)	m ²	0.05	0.15	0.45	0.80	0.80	0.75	0.50
Archisonic 12mm (50mm insulation)	m ²	0.35	0.85	1.00	1.00	1.00	1.00	1.00
Archisonic 24mm (no air gap)	m ²	0.05	0.25	0.55	1.05	1.05	1.10	0.55 (MH)
Archisonic 24mm (50mm air gap)	m ²	0.15	0.35	0.75	1.00	1.00	1.05	0.65 (MH)
Archisonic 24mm (50mm insulation)	m ²	0.40	0.90	1.00	1.00	1.00	1.00	1.00

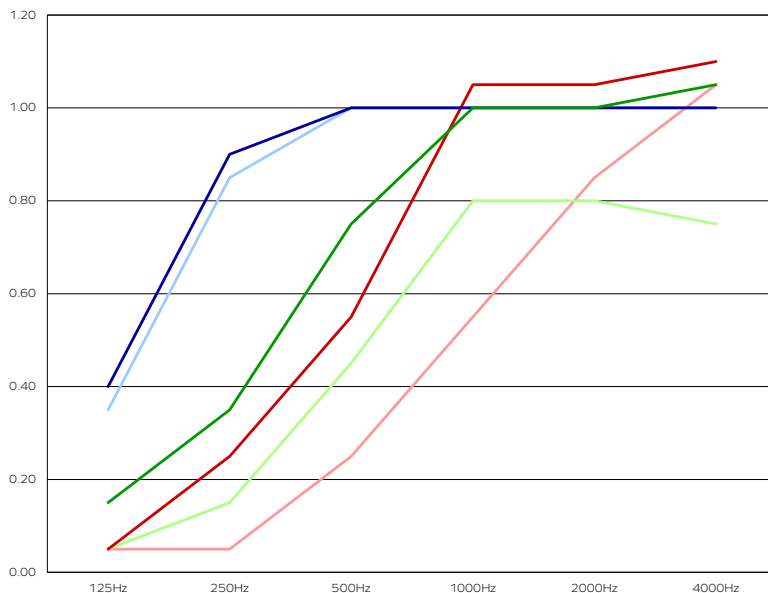

“It’s all about mass, depth and density when considering wall panels, the more surface you cover the more you can absorb. It’s not recommended to hang a wall panel on your colleague and turn him into a walking billboard as he won’t absorb your sense of humour.”

– Daniel Verlooven,
Global Acoustic Ambassador

- Wallcovering 12mm (no air gap)
- Wallcovering 24mm (no air gap)
- Wallcovering 12mm (50mm cavity)
- Wallcovering 24mm (50mm cavity)
- Wallcovering 12mm (50mm insulation)
- Wallcovering 24mm (50mm insulation)

The graph represents the sound absorption coefficients (α_s) in the third octave band center frequencies. Measurement used Pink Noise as excitation signal in a reverberant room.

Acoustic Test Results ASTM NRC

Archisonic 12mm (no air gap)	0.45
Archisonic 12mm (50mm air gap)	0.55
Archisonic 12mm (50mm insulation)	0.95
Archisonic 24mm (no air gap)	0.70
Archisonic 24mm (50mm air gap)	0.80
Archisonic 24mm (50mm insulation)	1.00



Wall Covering

Example projects

