

IMPACT ACOUSTIC®

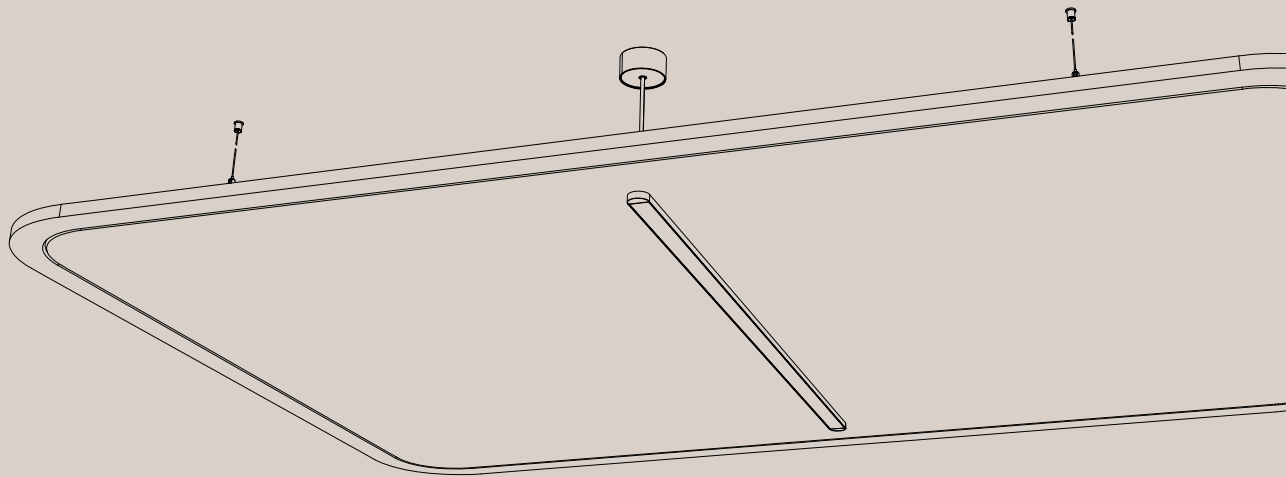

HABITAT  
MATTER

habitatmatter.com  
spec@habitatmatter.com



**Bysso**

Acoustic Lighting

723.24.20.000.00

723.24.21.000.00

723.24.22.000.00

TECHNICAL DATA SHEET

# Byzzo

## Acoustic Lighting

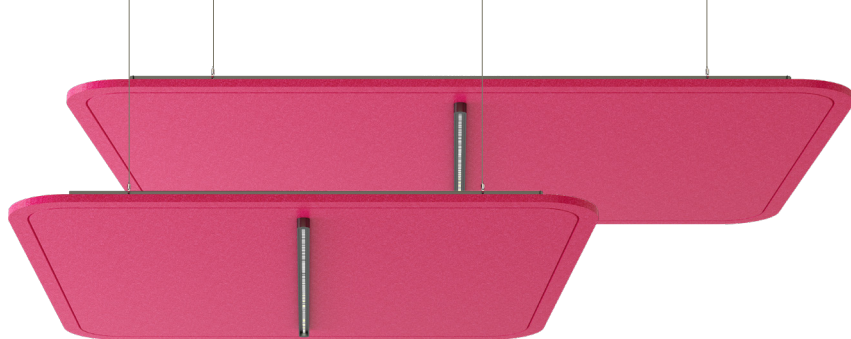

### PRODUCT DIMENSIONS

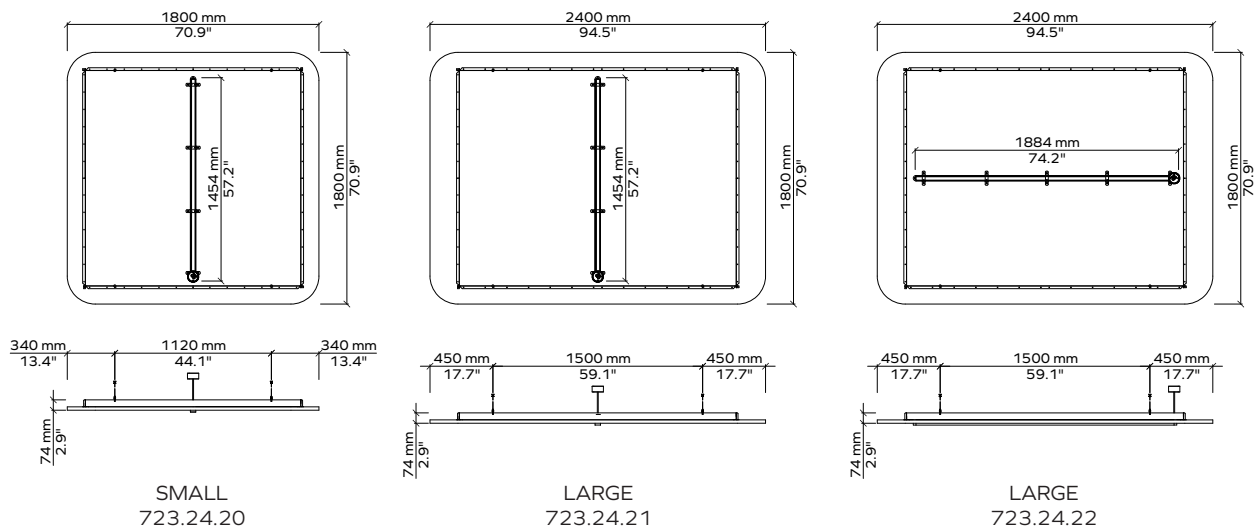

### ARTICLE NUMBERS

Lighting Product	Product Size	Color code	CCT	North American Market
723.24.	21 (Small)	Choose color as shown on pg. 3	27 (2700K)	Add an A at the end of the CCT code to indicate this product is for North America
	22 (Large)		30 (3000K)	
	23 (Large)		35 (3500K)	
			40 (4000K)	

**Example: 723.24.20.706.35A**

Byzzo Small [(1800x1800mm/70.9x70.9", Spearmint 706 color, 3500K CCT, 110-277V (North America)]

### LIGHTING SPECIFICATIONS

	Linear Light 1454	Linear Light 1884
Output	Direct Only	
Total Lumen Output (lm)	3061	3980
Wattage	31	41
Efficacy (lm/W)	98.74	97.07
Diffuser	Microprism	
Beam Angle	108	
CCT	2700-3000-3500-4000K	
CRI	90+	
MacAdam	3	
Dimming	0-10V 0.1% DSI/DALI	
Driver Location	On-Board	

### LIGHT DISTRIBUTION GRAPH

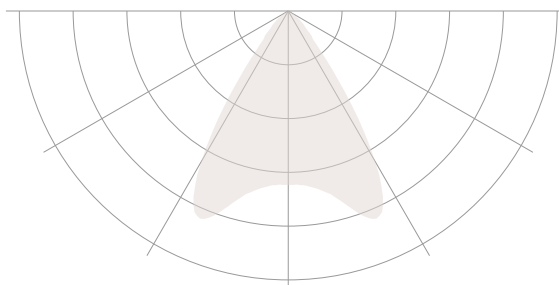

































### CERTIFICATIONS



# ARCHISONIC®

## Colors

 Material brochure available

								
<b>Name</b>	Snow White	Milk	Cloud	Smoke	Ground	Charcoal	Slate	Raven
<b>Color Code</b>	500	404	103	442	108	542	444	550
<b>NCS Code</b>	S 0300-N	S 0502-Y	S 1002-B	S 3005-R80B	S 5005-Y20R	S 7502-B	S 4500-N	S 8500-N
								
<b>Name</b>	Nordic Pine	Grove	Moss	Spearmint	Ice Blue	Succulent	Deep Sea	Marine Blue
<b>Color Code</b>	311	317	439	706	304	712	918	864
<b>NCS Code</b>	S 5030-G10Y	S 7020-G30Y	S 2040-G40Y	S 1010-B90G	S 0510-B	S 3020-B30G	S 5020-R90B	S 4050-R70B
								
<b>Name</b>	Linen	Shell Pink	Jute	Warm Stone	Terracotta	Soft Coral	Honeycomb	Sunshine
<b>Color Code</b>	107	102	920	105	239	516	139	846
<b>NCS Code</b>	S 1505-Y30R	S 0510-R30B	S 3010-Y30R	S 3010-Y50R	S 4040-Y70R	S 2020-Y90R	S 2050-Y20R	S 1040-Y10R
								
<b>Name</b>	Garnet	Hot Pink	Poster Red	Electric Orange	Winter Sky	Pacific Ocean	Midnight	Grape
<b>Color Code</b>	724	140	662	464	311	311	810	540
<b>NCS Code</b>	S 5040-R10B	S 2060-R20B	S 1080-R	S 0580-Y70R	S 5030-G10Y	S 5030-G10Y	S 7020-R70B	S 5040-R40B

These NCS codes are the closest visual match available and may not be exact to blended fibres.

**ARCHISONIC®**

## Colors

Experience our ARCHISONIC® Felt material with a stunning selection of 32 colors across 8 distinct families, thoughtfully curated by *Colour Hive* in London. Effortlessly combine colors harmoniously to suit your preferences. Discover more in our Materials brochure and order your free sample box today.

## Color fastness

Class 6

ISO 105-B02:A1

## Order a free sample box



**IMPACT ACOUSTIC®**  
Acoustic Lighting rev.01 - 11.08.23

(Switzerland)  
(USA)  
(Philippines)

connect@impactacoustic.com  
usa@impactacoustic.com  
philippines@impactacoustic.com

(+41) 41 566 55 55  
(+1) 646 918 1581  
(+63) 285 80 02 50



**HABITAT  
MATTER**

habitatmatter.com  
spec@habitatmatter.com



# Bysso

## Acoustic Lighting

### ACOUSTIC PERFORMANCE



#### ISO Standards

ISO 354:2003	Acoustics — Measurement of sound absorption in a reverberation room
ISO 11654:1997	Acoustics — Sound absorbers for use in buildings — Rating of sound absorption
ISO 20189:2018	Acoustics — Screens, furniture and single objects intended for interior use — Rating of sound absorption and sound reduction of elements based on laboratory measurements

#### Equivalent ASTM standards

ASTM C423-17	Standard Test Method for Sound Absorption and Sound Absorption Coefficients by the Reverberation Room Method
ASTM E795-16	Standard Practices for Mounting Test Specimens During Sound Absorption Tests

ISO	Equivalent Absorption Surface Area for the object (Aeq) (m <sup>2</sup> )	
Frequency (Hz)	Bysso (Small)	Bysso (Large)
125	1.30	1.70
250	2.40	3.20
500	3.00	4.00
1000	4.10	5.60
2000	4.90	6.60
4000	5.00	6.70

ASTM	Sabins (ft <sup>2</sup> )	
Frequency (Hz)	Bysso (Small)	Bysso (Large)
125	13.99	18.30
250	25.83	34.44
500	32.29	43.06
1000	44.13	60.28
2000	52.74	71.04
4000	53.82	72.12

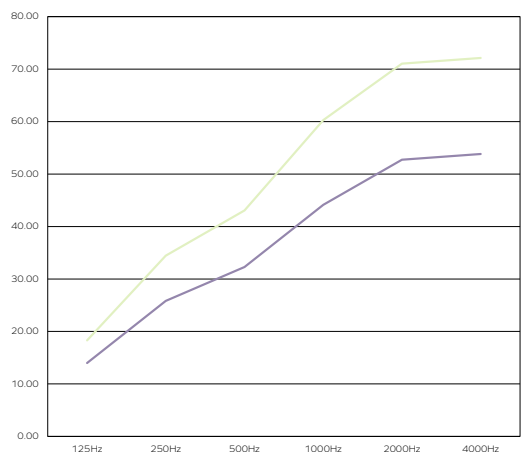
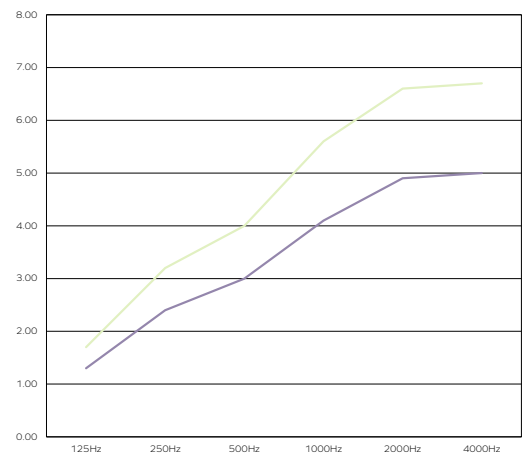

*“Just like sound, lighting appeals to the senses and is a driver for a good work environment and contributes to your health and well-being and should be synced with your circadian rhythm. However, if every evening you're the last person to switch off the lights in the office, you might have a tag on your back saying “overachiever”.*

- Daniel Verlooven

- Bysso Small - 1454 mm
- Bysso Large - 1884 mm



# ARCHISONIC®

## Material Specification

<b>Product Name</b>	Archisonic® Felt	
<b>Content</b>	100% PET (60% certified post-consumer content)	
<b>Thickness<sup>1</sup></b>	12mm (0.47")	24mm (0.94")
<b>Max. Size</b>	1200x2800mm (47"x110")	1800x2400mm (70"x94")
<b>Acoustic<sup>2</sup></b>	<b>ASTM:</b> NRC=0.6 <b>ISO:</b> αw=0.65	<b>ASTM:</b> NRC=0.9 <b>ISO:</b> αw=0.95
<b>Density<sup>1</sup></b>	2400 g/m <sup>2</sup> (0.49 lbs/ sqft)	4000 g/m <sup>2</sup> (0.82 lbs/sqft)
<b>Color Fastness</b>	<b>Class 6</b> ISO 105-B02:A1	
<b>Color</b>	<b>32 colors</b> (see Archisonic® Felt Color page for more information)	
<b>Maintenance</b>	For daily cleaning we recommend alcohol solution (75%), e.g. Pantasept. In case of contamination by dust or fluff, use feather duster or a regular vacuum cleaner. For heavy dirt, treat the material with hydrogen peroxide.	
<b>Lead time<sup>3</sup></b>	21 days	
<b>Fire Rating</b>	DIN EN 13501-1: <b>B-s1, d0</b>	ASTM E84 <b>Class A</b>
<b>VOC Emission</b>	<b>A+</b> 28 Days French Regulation	ASTM E84 <b>Pass</b>
<b>Certifications</b>	Declare label, Cradle to Cradle, UL Environmental Product Declaration, Member of US Green Building Council, Ecobau 1st Priority, Climate-KIC, VOC emissions in LEED EQ credit (low-emitting products), Bream, SCS Recycled Content	
<b>Durability</b>	Contract	

1 - all values are nominal 2 - measured with 300mm air cavity 3 - depending on the location and type of product



Climate-KIC is supported by the EIT, a body of the European Union



**Declare.**

