

# Web, Bubble, Forest, Jungle

## Round Ceiling Panels

711.24.17.000.10	711.24.17.000.12
711.24.18.000.10	711.24.18.000.12
711.24.20.000.00	711.24.24.000.00
711.24.21.000.00	711.24.25.000.00

# Web, Bubble, Forest and Jungle

## General Information

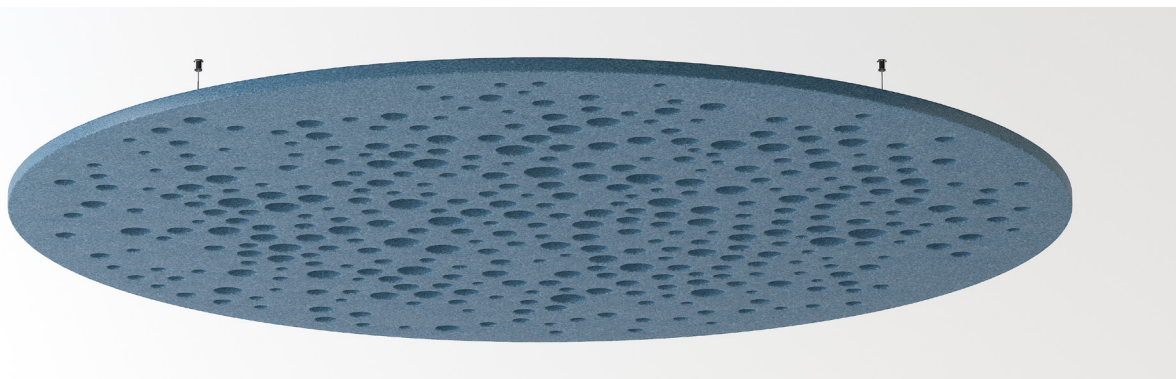

### Data

#### Applicable article numbers

711.24.17.000.10	711.24.17.000.12	711.24.21.000.00	711.24.24.000.00
711.24.18.000.10	711.24.18.000.12	711.24.21.000.00	711.24.25.000.00

#### Dimensions<sup>1</sup>

Diameter	1200 or 1800mm	47.24" or 70.87"
Material thickness	24mm	0.94"

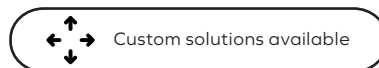

#### Material

Panel 100% PET (60% post-consumer) in 32 colors.

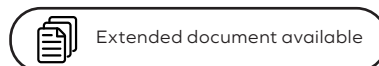

#### Weight<sup>2</sup>

24mm PET Material 4kg/m<sup>2</sup> kg (±10%) 0.82 lbs/ft<sup>2</sup> (±10%)

*(for specific product weight please refer to Geometry Information pages 5-10)*

### Included

Ceiling Panel



Installation Kit



Installation guide



Warranty 2 years<sup>3</sup>



1 - all dimensions are nominal 2 - all weight values are nominal 3 - Impact Acoustic warranty terms apply

**IMPACT ACOUSTIC®**  
Ceiling Panels Round rev.01 - 07.09.23

(Switzerland)  
(USA)  
(Philippines)

connect@impactacoustic.com  
usa@impactacoustic.com  
philippines@impactacoustic.com

(+41) 41 566 55 55  
(+1) 646 918 1581  
(+63) 285 80 02 50



**HABITAT  
MATTER**

habitatmatter.com  
spec@habitatmatter.com

# Web, Bubble, Forest and Jungle

## Specification Guide

Ensure you make the perfect choice by choosing our solutions for your next project. To get started, simply define some basic information and constraints about your space. Then explore our range of standard solutions or contact us directly for a more in-depth discussion of personalised customized options.

### 1 Prepare this information:

---

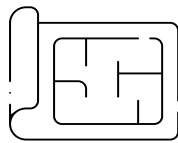

Ceiling Plans (RCP)

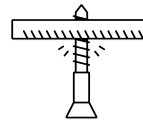

Ceiling Type

### 2 Specify your Baffles:

---

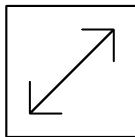

Size

page 5 and 6

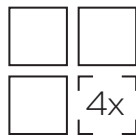

Number of Modules

page 4

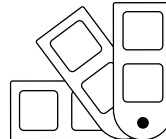

Color

page 8

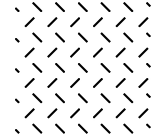

Pattern

page 8

### 3 Verify installation method:

---

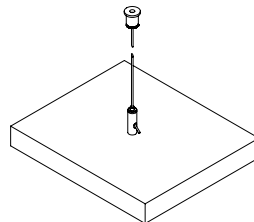

Direct gripper

page 7



# Web, Bubble, Forest and Jungle

## Product Family Overview

### 3 Ceiling Panels Round Perforated

711.24.17.000.12 - Ceiling Panel Round Bubbles

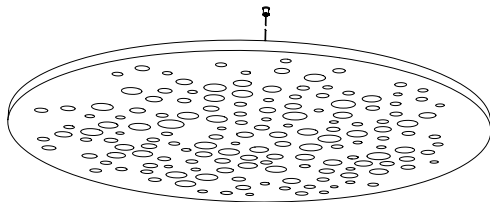

(D1200 x 24mm)  
(D47.24" x 0.94")

711.24.18.000.12 - Ceiling Panel Round Bubbles

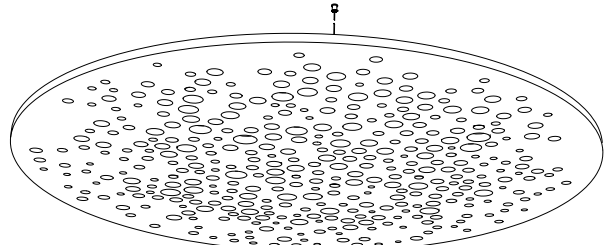

(D1800 x 24mm)  
(D70.87" x 0.94")

711.24.17.000.10 - Ceiling Panel Round Web

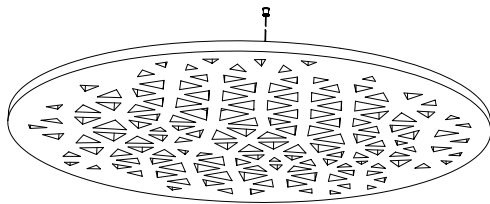

(D1200 x 24mm)  
(D47.24" x 0.94")

711.24.18.000.10 - Ceiling Panel Round Web

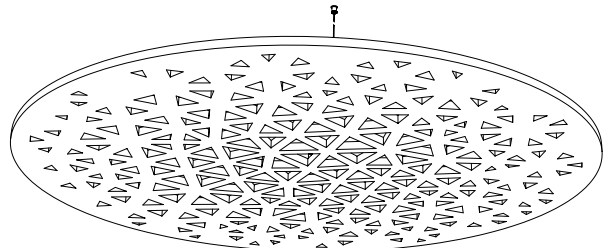

(D1800 x 24mm)  
(D70.87" x 0.94")

711.24.20.000.00 - Ceiling Panel Round Forest

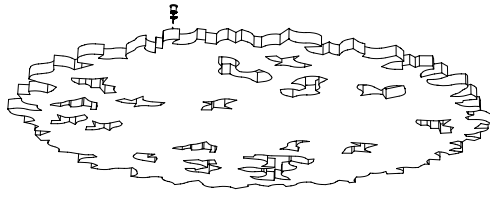

(D1200 x 24mm)  
(D47.24" x 0.94")

711.24.21.000.00 - Ceiling Panel Round Forest

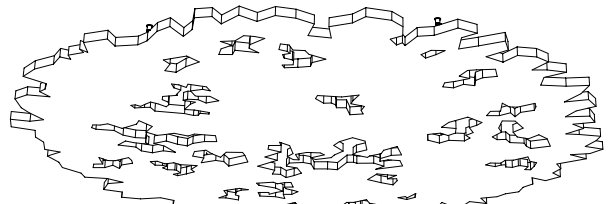

(D1800 x 24mm)  
(D70.87" x 0.94")

711.24.20.000.00 - Ceiling Panel Round Jungle

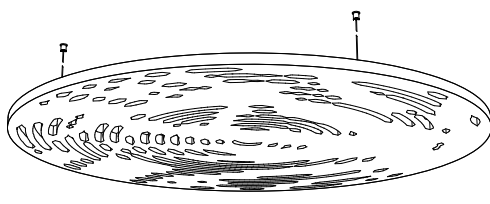

(D1200 x 24mm)  
(D47.24" x 0.94")

711.24.21.000.00 - Ceiling Panel Round Jungle

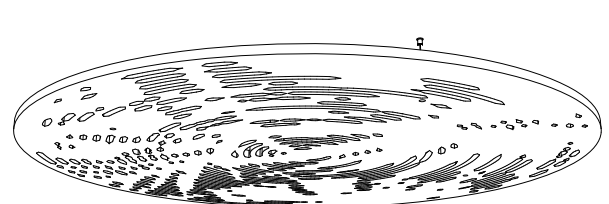

(D1800 x 24mm)  
(D70.87" x 0.94")

## Geometry Information

### Ceiling Panel Round 711.24.17.000.10

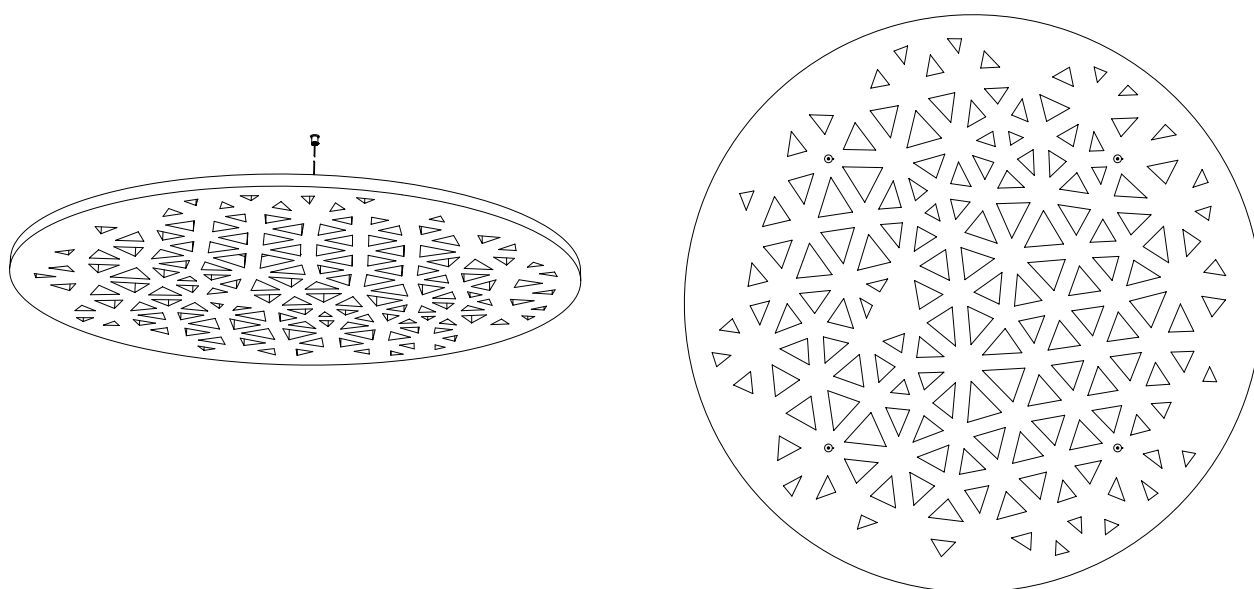
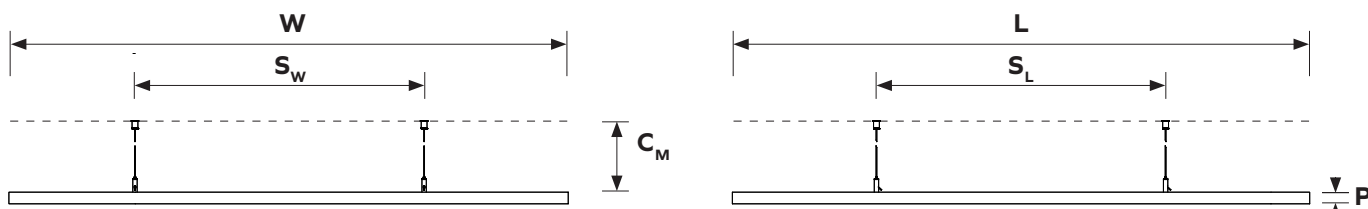

Dimensions table <sup>1</sup>

<b>W</b>	Total width	1195mm	47.05"
<b>L</b>	Total length	1195mm	47.05"
<b>C<sub>M</sub></b>	Distance from ceiling	min. 100mm	min. 4"
<b>S<sub>w</sub></b>	Support spacing W	595mm	23.43"
<b>S<sub>L</sub></b>	Support spacing L	595mm	23.43"
<b>P</b>	PET material thickness	24mm	0.94"

Weight table <sup>2</sup>

PET panel	3.68 kg	8.11 lbs
-----------	---------	----------

1 - all dimensions are nominal 2 - all weight values are nominal

## Geometry Information

### Ceiling Panel Round 711.24.18.000.10

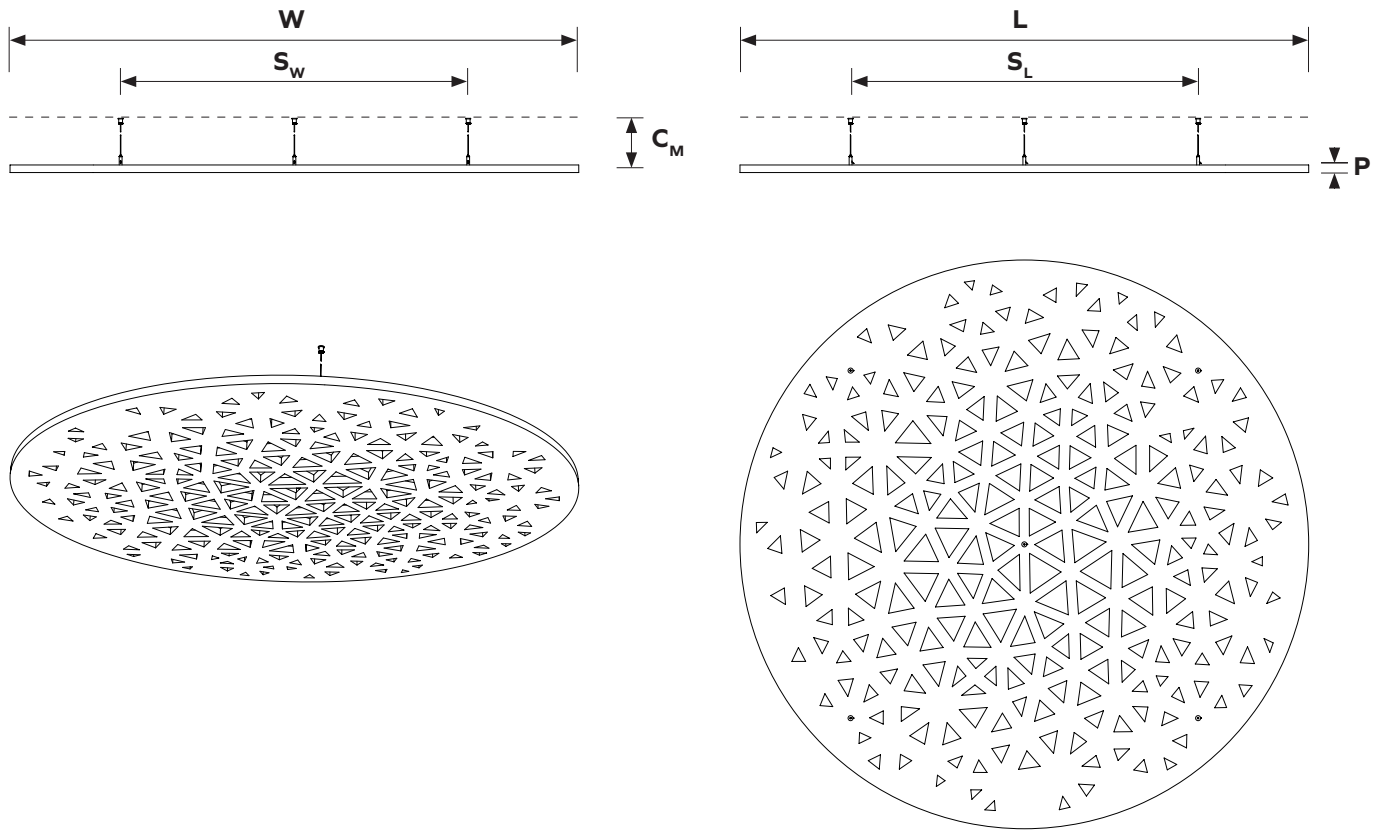

Dimensions table <sup>1</sup>

<b>W</b>	Total width	1800mm	70.87"
<b>L</b>	Total length	1800mm	70.87"
<b>C<sub>M</sub></b>	Distance from ceiling	min. 100mm	min. 4"
<b>S<sub>w</sub></b>	Support spacing W	1100mm	23.43"
<b>S<sub>L</sub></b>	Support spacing L	1100mm	23.43"
<b>P</b>	PET material thickness	24mm	0.94"

Weight table <sup>2</sup>

PET panel	8.43 kg	18.58 lbs
-----------	---------	-----------

1 - all dimensions are nominal 2 - all weight values are nominal

# Bubble

## Geometry Information

Custom solutions available

### Ceiling Panel Round 711.24.17.000.12

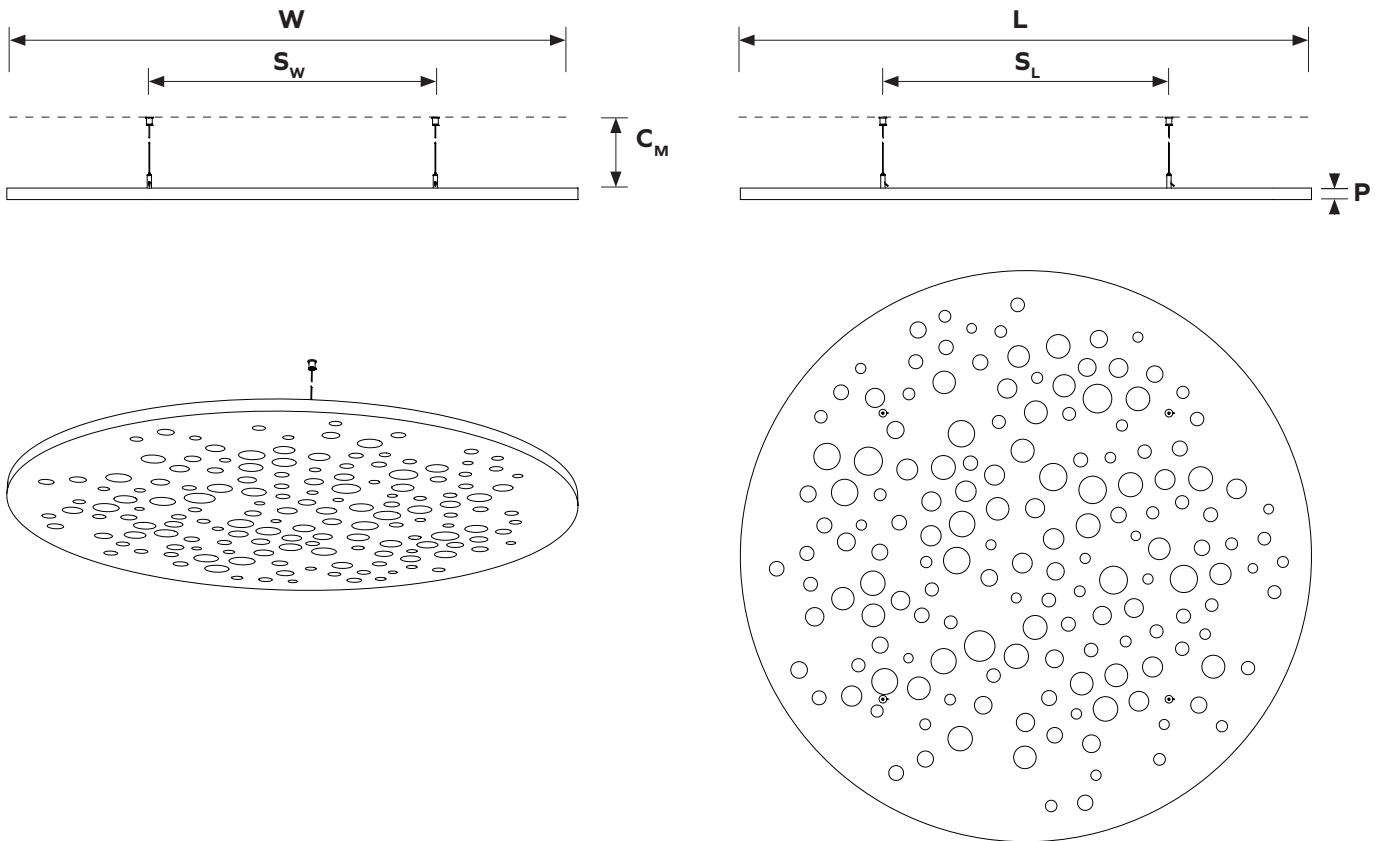

Dimensions table <sup>1</sup>

<b>W</b>	Total width	1195mm	47.05"
<b>L</b>	Total length	1195mm	47.05"
<b>C<sub>M</sub></b>	Distance from ceiling	min. 100mm	min. 4"
<b>S<sub>w</sub></b>	Support spacing W	595mm	23.43"
<b>S<sub>L</sub></b>	Support spacing L	595mm	23.43"
<b>P</b>	PET material thickness	24mm	0.94"

Weight table <sup>2</sup>

PET panel	3.77 kg	8.31 lbs
-----------	---------	----------

1 - all dimensions are nominal 2 - all weight values are nominal



# Bubble

## Geometry Information

Custom solutions available

### Ceiling Panel Round 711.24.18.000.12

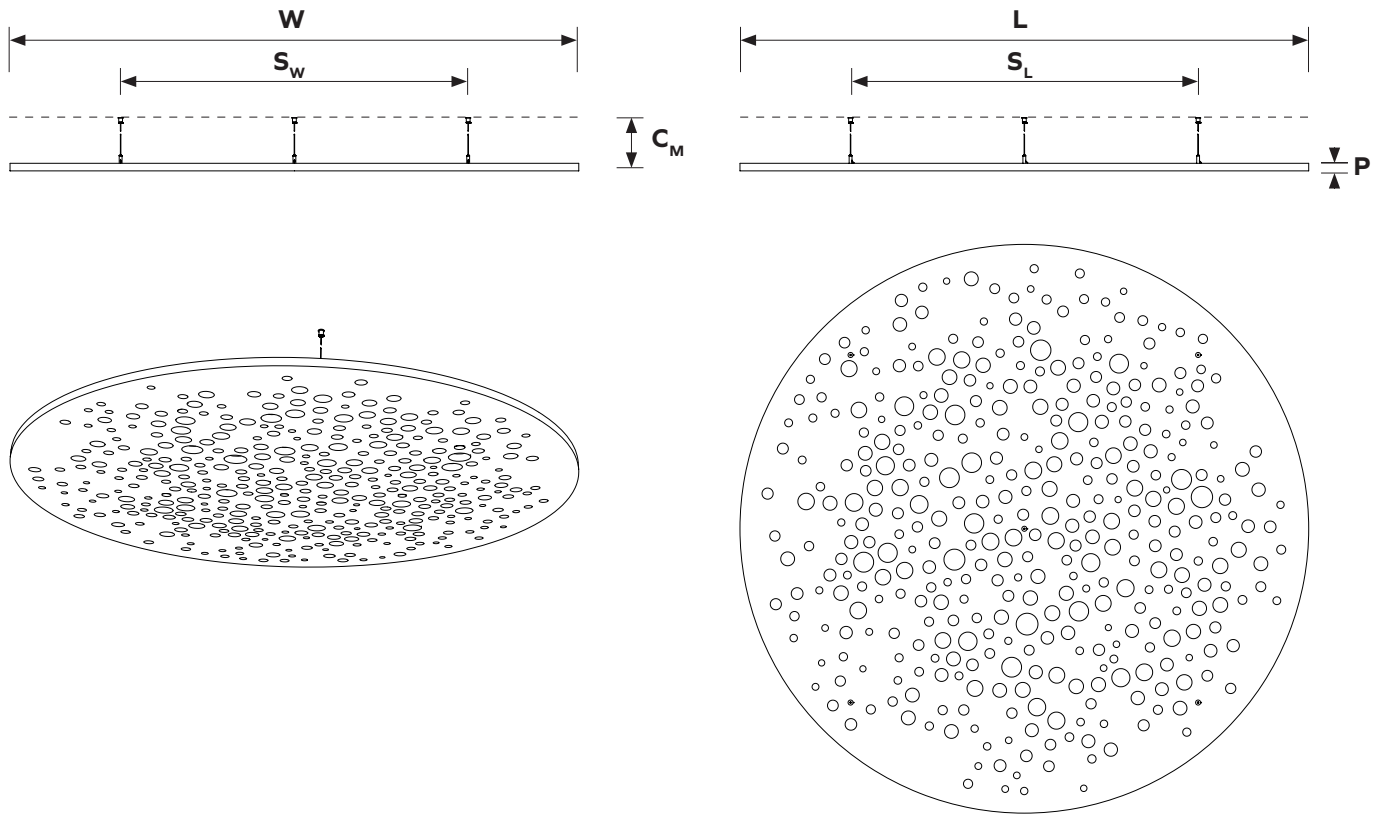

Dimensions table <sup>1</sup>

<b>W</b>	Total width	1800mm	70.87"
<b>L</b>	Total length	1800mm	70.87"
<b>C<sub>M</sub></b>	Distance from ceiling	min. 100mm	min. 4"
<b>S<sub>W</sub></b>	Support spacing W	1100mm	23.43"
<b>S<sub>L</sub></b>	Support spacing L	1100mm	23.43"
<b>P</b>	PET material thickness	24mm	0.94"

Weight table <sup>2</sup>

PET panel	8.50 kg	18.74 lbs
-----------	---------	-----------

1 - all dimensions are nominal 2 - all weight values are nominal





# Forest

## Geometry Information

Custom solutions available

### Ceiling Panel Round 711.24.20.000.00

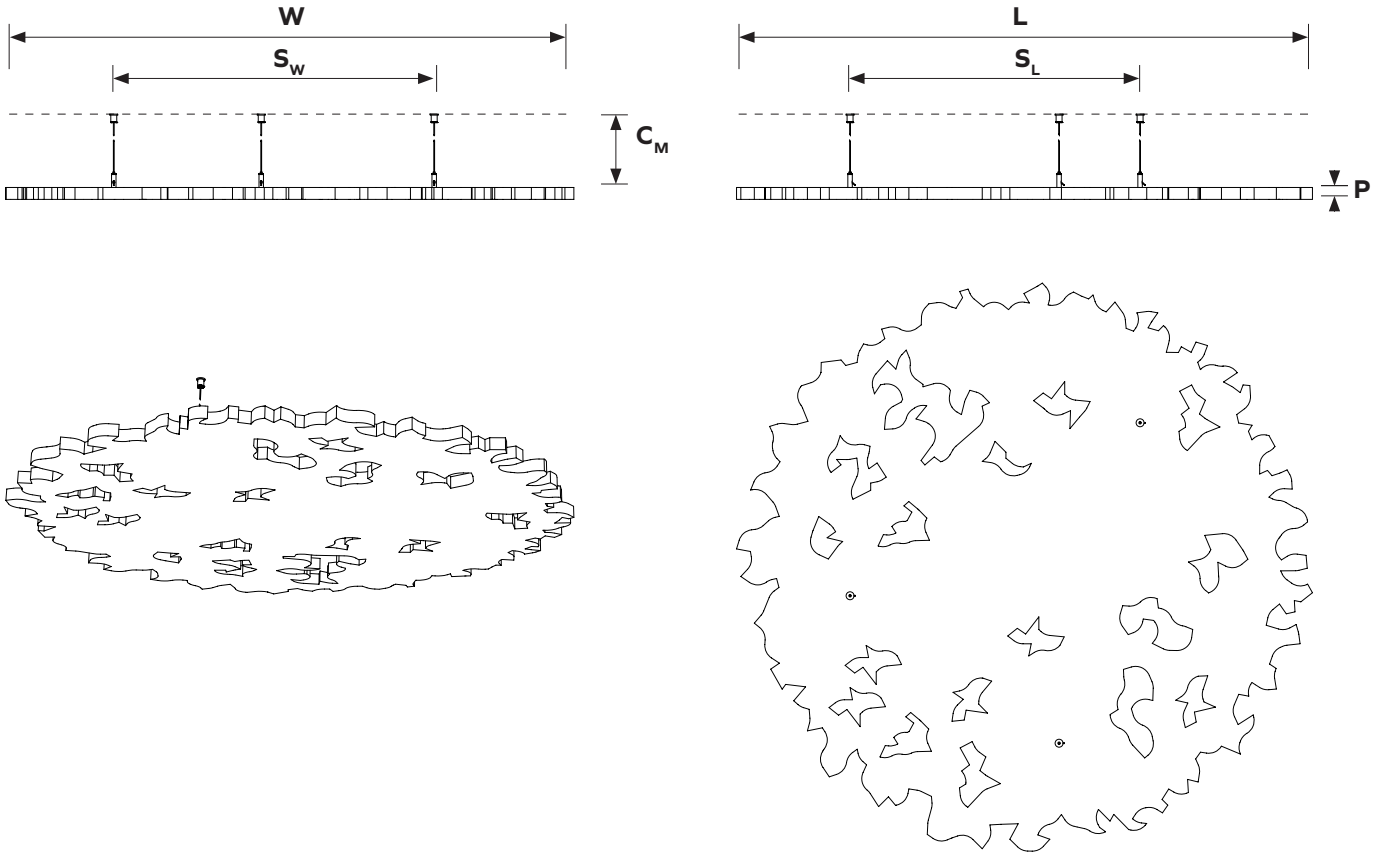

Dimensions table <sup>1</sup>

<b>W</b>	Total width	1145mm	45.08"
<b>L</b>	Total length	1160mm	45.67"
<b>C<sub>M</sub></b>	Distance from ceiling	min. 100mm	min. 4"
<b>S<sub>W</sub></b>	Support spacing W	680mm	26.77"
<b>S<sub>L</sub></b>	Support spacing L	515mm	20.28"
<b>P</b>	PET material thickness	24mm	0.94"

Weight table <sup>2</sup>

PET panel	3.35 kg	7.39 lbs
-----------	---------	----------

1 - all dimensions are nominal 2 - all weight values are nominal



# Forest

## Geometry Information

Custom solutions available

### Ceiling Panel Round 711.24.21.000.00

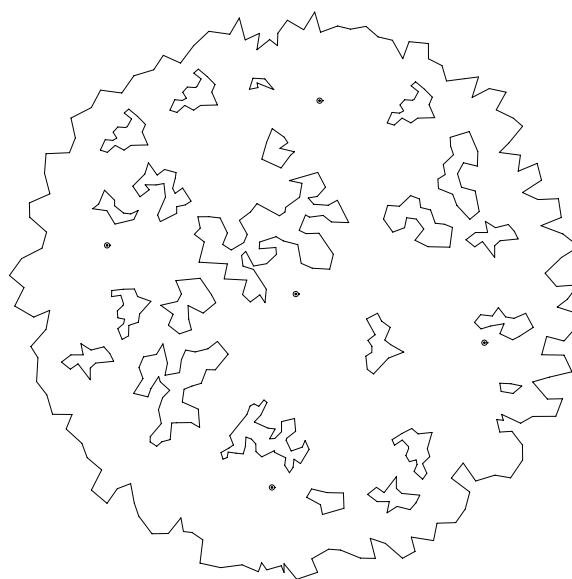
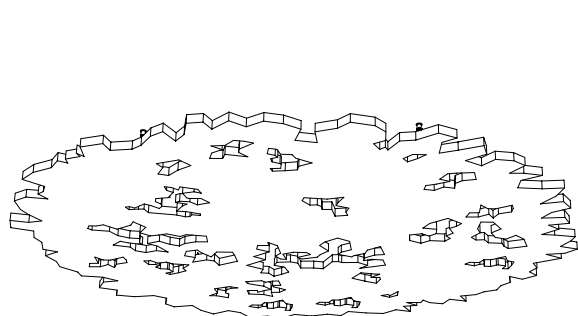
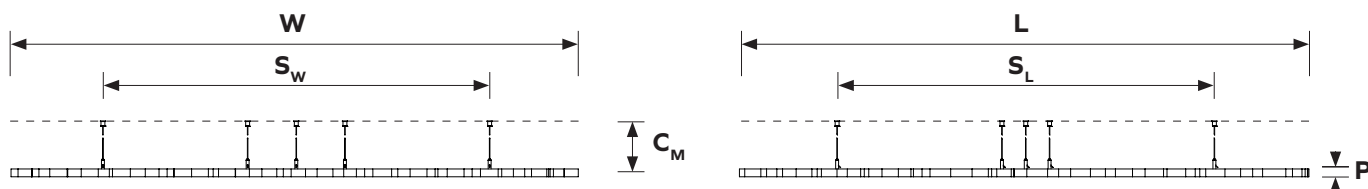

Dimensions table <sup>1</sup>

<b>W</b>	Total width	1743mm	68.62"
<b>L</b>	Total length	1750mm	68.90"
<b>C<sub>M</sub></b>	Distance from ceiling	min. 100mm	min. 4"
<b>S<sub>w</sub></b>	Support spacing W	1197mm	47.13"
<b>S<sub>L</sub></b>	Support spacing L	1197mm	47.13"
<b>P</b>	PET material thickness	24mm	0.94"

Weight table <sup>2</sup>

PET panel	7.56 kg	16.67 lbs
-----------	---------	-----------

1 - all dimensions are nominal 2 - all weight values are nominal

**IMPACT ACOUSTIC®**  
Ceiling Panels Round rev.01 - 07.09.23

(Switzerland)  
(USA)  
(Philippines)

connect@impactacoustic.com  
usa@impactacoustic.com  
philippines@impactacoustic.com

(+41) 41 566 55 55  
(+1) 646 918 1581  
(+63) 285 80 02 50



**HABITAT  
MATTER**

habitatmatter.com  
spec@habitatmatter.com

# Jungle

## Geometry Information

Custom solutions available

### Ceiling Panel Round 711.24.24.000.10

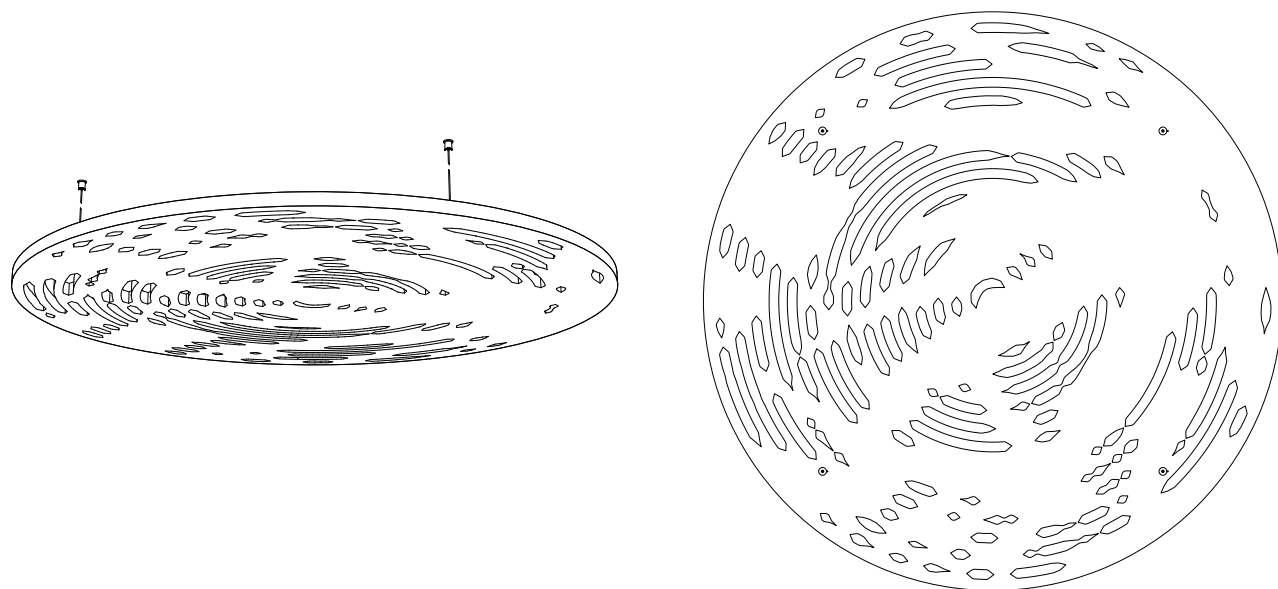
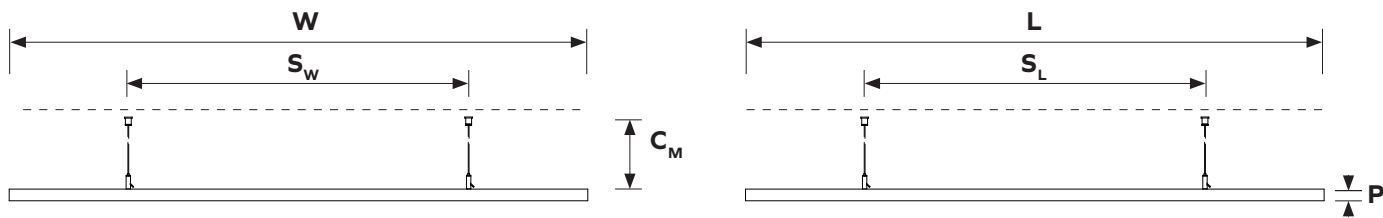

Dimensions table <sup>1</sup>

<b>W</b>	Total width	1195mm	47.05"
<b>L</b>	Total length	1195mm	47.05"
<b>C<sub>M</sub></b>	Distance from ceiling	min. 100mm	min. 4"
<b>S<sub>w</sub></b>	Support spacing W	700 mm	27.56"
<b>S<sub>L</sub></b>	Support spacing L	700 mm	27.56"
<b>P</b>	PET material thickness	24mm	0.94"

Weight table <sup>2</sup>

PET panel	3.68 kg	8.11 lbs
-----------	---------	----------

1 - all dimensions are nominal 2 - all weight values are nominal



# Jungle

## Geometry Information

Custom solutions available

### Ceiling Panel Round 711.24.25.000.10

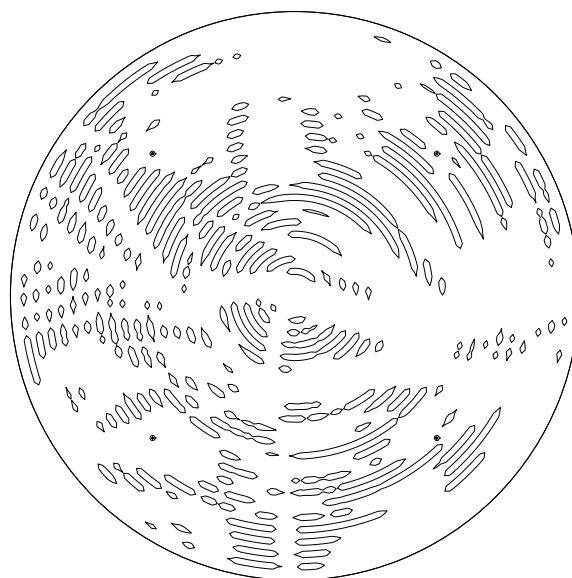
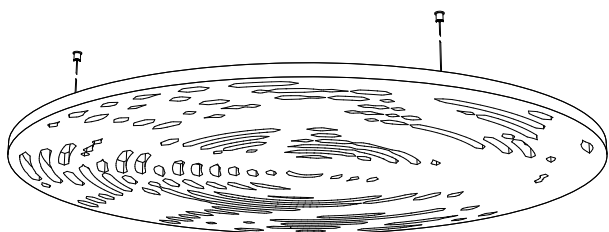
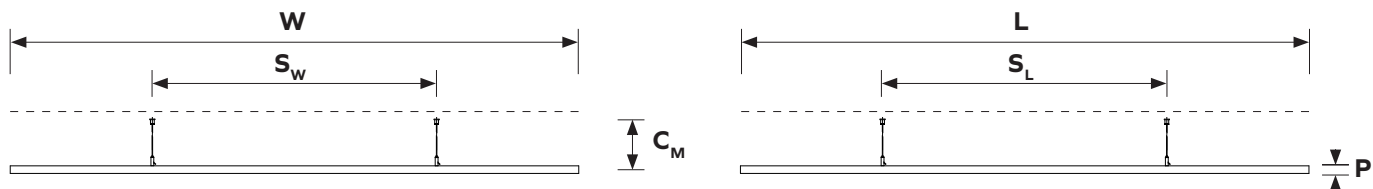

Dimensions table <sup>1</sup>

<b>W</b>	Total width	1800mm	70.87"
<b>L</b>	Total length	1800mm	70.87"
<b>C<sub>M</sub></b>	Distance from ceiling	min. 100mm	min. 4"
<b>S<sub>w</sub></b>	Support spacing W	900 mm	35.43"
<b>S<sub>L</sub></b>	Support spacing L	900 mm	35.43"
<b>P</b>	PET material thickness	24mm	0.94"

Weight table <sup>2</sup>

PET panel	8.43 kg	18.58 lbs
-----------	---------	-----------

1 - all dimensions are nominal 2 - all weight values are nominal



# Web, Bubble, Forest and Jungle



Extended document available

## Installation Overview

### 1 Attach mounting hardware

Measure the right spacing according to the X marks on the panel and attach mounting cables to the ceiling.

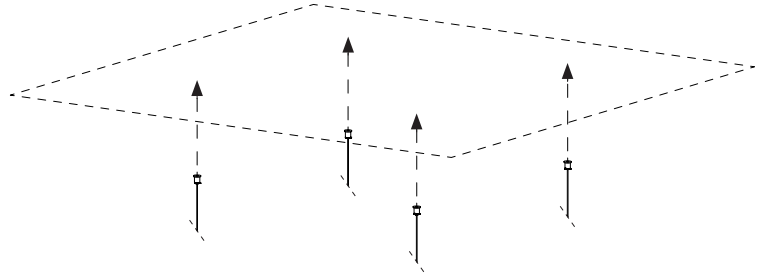

### 2 Attach grippers to the panel

Screw the cable grippers into the panel at the locations indicated by X mark on the panel back surface.

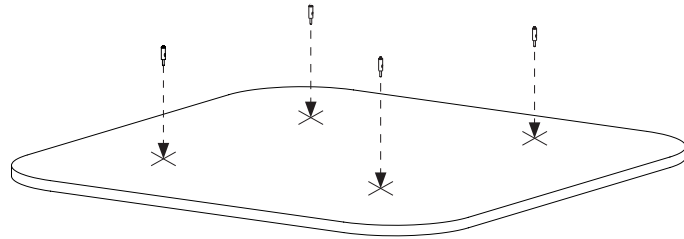

### 3 Connect cables



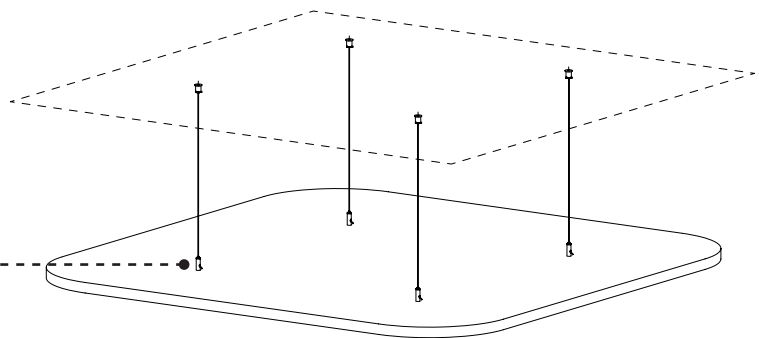
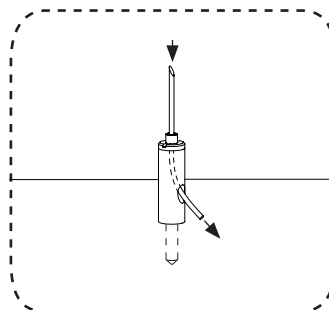





























Pull suspension cables through Grippers and adjust the cable length.



# ARCHISONIC®

## Colors

 Material brochure available

								
<b>Name</b>	Snow White	Milk	Cloud	Smoke	Ground	Charcoal	Slate	Raven
<b>Color Code</b>	500	404	103	442	108	542	444	550
<b>NCS Code</b>	S 0300-N	S 0502-Y	S 1002-B	S 3005-R80B	S 5005-Y20R	S 7502-B	S 4500-N	S 8500-N
								
<b>Name</b>	Nordic Pine	Grove	Moss	Spearmint	Ice Blue	Succulent	Deep Sea	Marine Blue
<b>Color Code</b>	311	317	439	706	304	712	918	864
<b>NCS Code</b>	S 5030-G10Y	S 7020-G30Y	S 2040-G40Y	S 1010-B90G	S 0510-B	S 3020-B30G	S 5020-R90B	S 4050-R70B
								
<b>Name</b>	Linen	Shell Pink	Jute	Warm Stone	Terracotta	Soft Coral	Honeycomb	Sunshine
<b>Color Code</b>	107	102	920	105	239	516	139	846
<b>NCS Code</b>	S 1505-Y30R	S 0510-R30B	S 3010-Y30R	S 3010-Y50R	S 4040-Y70R	S 2020-Y90R	S 2050-Y20R	S 1040-Y10R
								
<b>Name</b>	Garnet	Hot Pink	Poster Red	Electric Orange	Winter Sky	Pacific Ocean	Midnight	Grape
<b>Color Code</b>	724	140	662	464	311	311	810	540
<b>NCS Code</b>	S 5040-R10B	S 2060-R20B	S 1080-R	S 0580-Y70R	S 5030-G10Y	S 5030-G10Y	S 7020-R70B	S 5040-R40B

These NCS codes are the closest visual match available and may not be exact to blended fibres.

**ARCHISONIC®**

## Colors

Experience our ARCHISONIC® Felt material with a stunning selection of 32 colors across 8 distinct families, thoughtfully curated by *Colour Hive* in London. Effortlessly combine colors harmoniously to suit your preferences. Discover more in our Materials brochure and order your free sample box today.

## Color fastness

Class 6

ISO 105-B02:A1

## Order a free sample box



# ARCHISONIC®

## Material Specification

<b>Product Name</b>	Archisonic® Felt	
<b>Content</b>	100% PET (60% certified post-consumer content)	
<b>Thickness<sup>1</sup></b>	12mm (0.47")	24mm (0.94")
<b>Max. Size</b>	1200x2800mm (47"x110")	1800x2400mm (70"x94")
<b>Acoustic<sup>2</sup></b>	<b>ASTM:</b> NRC=0.6 <b>ISO:</b> $\alpha_w$ =0.65	<b>ASTM:</b> NRC=0.9 <b>ISO:</b> $\alpha_w$ =0.95
<b>Density<sup>1</sup></b>	2400 g/m <sup>2</sup> (0.49 lbs/ sqft)	4000 g/m <sup>2</sup> (0.82 lbs/sqft)
<b>Color Fastness</b>	<b>Class 6</b> ISO 105-B02:A1	
<b>Color</b>	<b>32 colors</b> (see Archisonic® Felt Color page for more information)	
<b>Maintenance</b>	For daily cleaning we recommend alcohol solution (75%), e.g. Pantasept. In case of contamination by dust or fluff, use feather duster or a regular vacuum cleaner. For heavy dirt, treat the material with hydrogen peroxide.	
<b>Lead time<sup>3</sup></b>	21 days	
<b>Fire Rating</b>	DIN EN 13501-1: <b>B-s1, d0</b>	ASTM E84 <b>Class A</b>
<b>VOC Emission</b>	<b>A+</b> 28 Days French Regulation	ASTM E84 <b>Pass</b>
<b>Certifications</b>	Declare label, Cradle to Cradle, UL Environmental Product Declaration, Member of US Green Building Council, Ecobau 1st Priority, Climate-KIC, VOC emissions in LEED EQ credit (low-emitting products), Breeam, SCS Recycled Content	
<b>Durability</b>	Contract	

1 - all values are nominal 2 - measured with 300mm air cavity 3 - depending on the location and type of product



Climate-KIC is supported by the EIT, a body of the European Union



**Declare.**



# Web, Bubble, Forest and Jungle

## Acoustic Performance



### Testing Standards

ISO 354:2003	Acoustics — Measurement of sound absorption in a reverberation room
ISO 11654:1997	Acoustics — Sound absorbers for use in buildings — Rating of sound absorption
ISO 20189:2018	Acoustics — Screens, furniture and single objects intended for interior use — Rating of sound absorption and sound reduction of elements based on laboratory measurements
ASTM C423-17	Standard Test Method for Sound Absorption and Sound Absorption Coefficients by the Reverberation Room Method
ASTM E795-16	Standard Practices for Mounting Test Specimens During Sound Absorption Tests

### Acoustic Test Results ISO

Frequency (Hz)		125	250	500	1000	2000	4000	$\alpha_w$
24mm ROUND BUBBLES D1200mm	m <sup>2</sup>	0.2	0.5	0.8	1.2	1.6	1.7	NA
24mm ROUND BUBBLES D1800mm	m <sup>2</sup>	0.5	1.1	1.8	2.8	3.5	3.9	NA
24mm ROUND WEB D1200mm	m <sup>2</sup>	0.2	0.5	0.8	1.2	1.5	1.7	NA
24mm ROUND WEB D1800mm	m <sup>2</sup>	0.5	1.1	1.8	2.8	3.5	3.8	NA
24mm Forest D1200	m <sup>2</sup>	0.2	0.4	0.7	1.1	1.4	1.5	NA
24mm Forest D1800	m <sup>2</sup>	0.5	1.0	1.6	2.5	3.1	3.4	NA

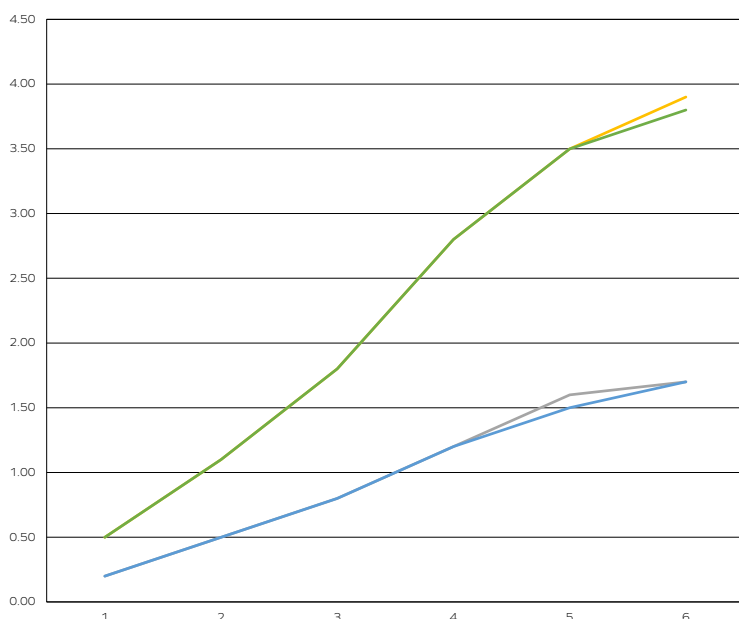

The graph represents the sound absorption coefficients ( $\alpha_s$ ) in the third octave band center frequencies. Measurement used Pink Noise as excitation signal in a reverberant room.

### Acoustic Test Results ASTM

Acoustic Test Results ASTM	NRC
24mm ROUND BUBBLES D1200mm	0.60
24mm ROUND BUBBLES D1800mm	0.55
24mm ROUND WEB D1200mm	0.60
24mm ROUND WEB D1800mm	0.60
24mm Forest D1200	0.55
24mm Forest D1800	0.55

- 24mm ROUND BUBBLES D1200mm
- 24mm ROUND BUBBLES D1800mm
- 24mm ROUND WEB D1200mm
- 24mm ROUND WEB D1800mm
- 24mm Forest D1200
- 24mm Forest D1800
- 24mm ROUND JUNGLE D1200mm
- 24mm ROUND JUNGLE D1800mm





# Web, Bubble and Forest

## Reference Projects

