

IMPACT ACOUSTIC®

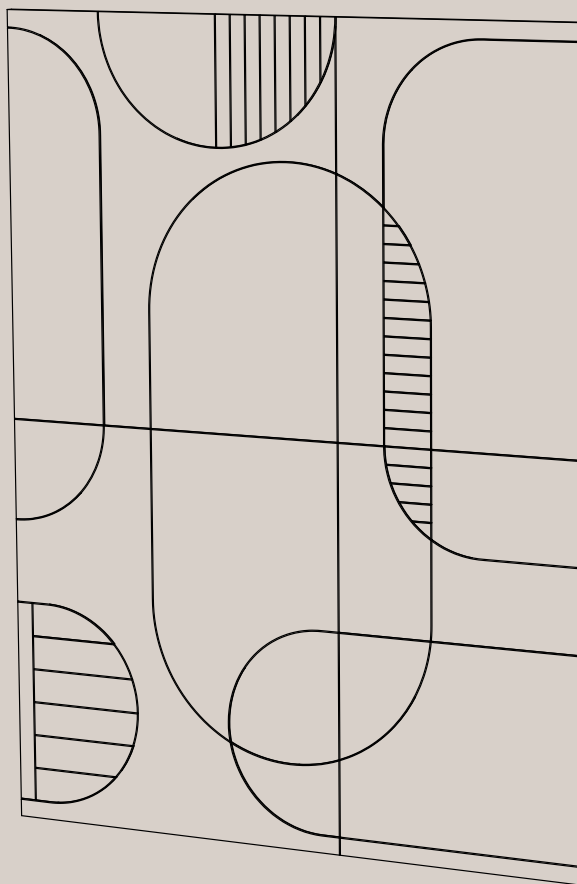

HABITAT  
MATTER

habitatmatter.com  
spec@habitatmatter.com



# Vela

## Wall Covering

732.24.28.000.00

732.12.28.000.00



# Vela

## General Information

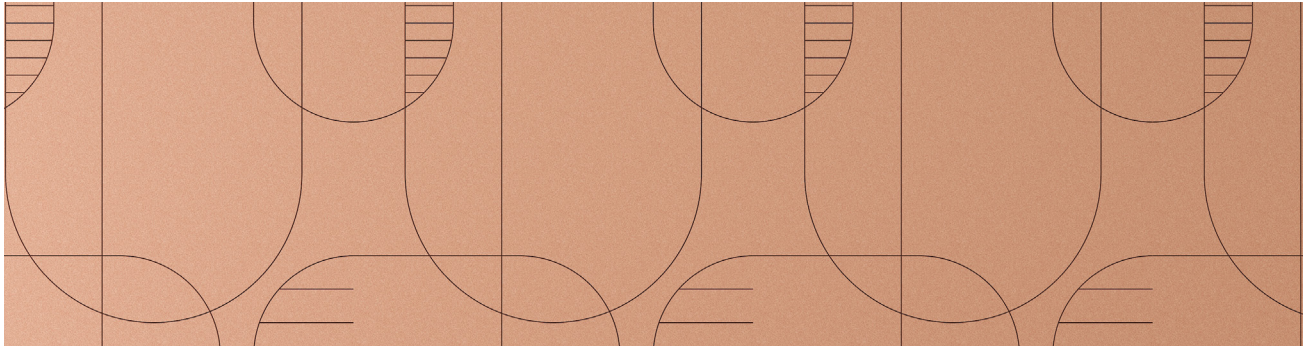

## Data

### Applicable article numbers

732.24.28.000.00

732.12.28.000.00

### Total Dimensions<sup>3</sup>

	24mm / 12 mm	0.9" / 0.5"
Height	2400mm / 2800mm	95" / 110"
Weight	1800mm / 1200mm	71" / 47"



Custom solutions available

### Material

Wall Covering	100% PET (60% post-consumer) in 32 colors
Glue	Spray Glue



Extended document available

### Weight<sup>1</sup>

24mm / 0.95"	4 kg/m <sup>2</sup>	0.82 lbs/sq.ft
12mm / 0.47"	2.4 kg/m <sup>2</sup>	0.49 lbs/sq.ft

## Included

PET Panels



Spray glue



Installation  
guide



Warranty  
2 years<sup>2</sup>



1 - all weights are nominal

2 - Impact Acoustic warranty terms apply

3 - all dimensions are nominal



# Vela

## Specification Guide

Ensure you make the perfect choice by choosing our solutions for your next project. To get started, simply define some basic information and constraints about your space. Then explore our range of standard solutions or contact us directly for a more in-depth discussion of personalised customized options.

### 1 Prepare this information:

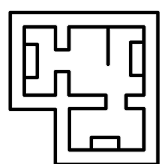

Project Area

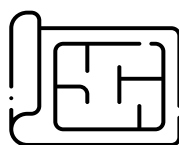

Plans



Other Considerations

### 2 Specify your Wall Covering:

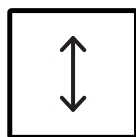

Material thickness

page 4-5

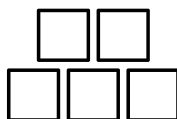

Quantity

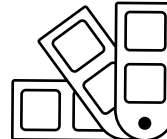

Color

page 6

### 3 Article numbers:

732	Material Thickness <sup>3</sup>	28	Colour	00
732	24mm	28	Choose colour as shown on p. 6	00
	12mm			

**Example: 732.24.28.662.00**

Wall Covering - Vela, 2400 x 1800 x 24mm, 662 - Poster Red incl. spray glue



# Vela

## Geometry Information

### Applicable articles numbers

732.24.28.000.00

### Scope of delivery

For each item you will receive a set of 1x PET panels (in the dimensions below), 1x spray adhesive can per set.

### Applicable articles numbers

These panels are mounted with a contact spray adhesive. Instructions are available online.

## Vela 24mm

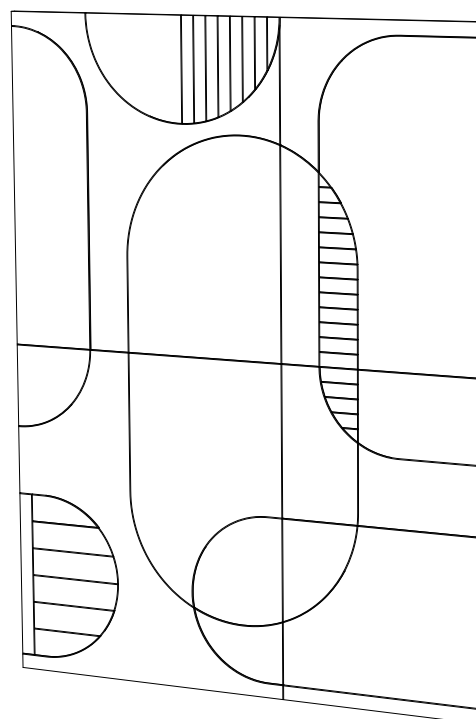
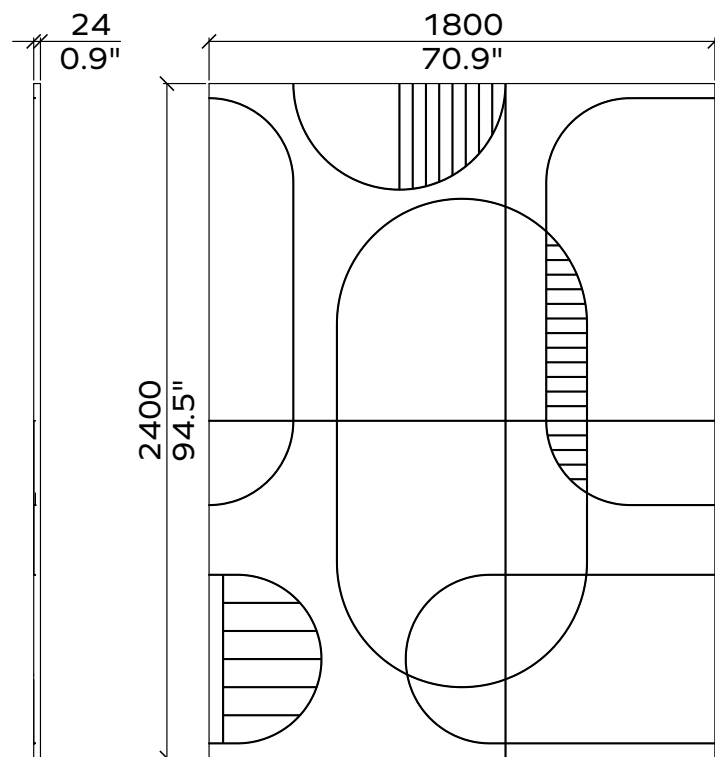
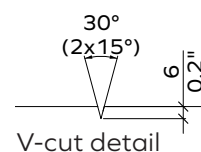

all dimensions are nominal



# Vela

## Geometry Information

### Applicable articles numbers

732.12.28.000.00

### Scope of delivery

For each item you will receive a set of 1x PET panels (in the dimensions below), 1x spray adhesive can per set.

### Applicable articles numbers

These panels are mounted with a contact spray adhesive. Instructions are available online.

## Vela 12mm

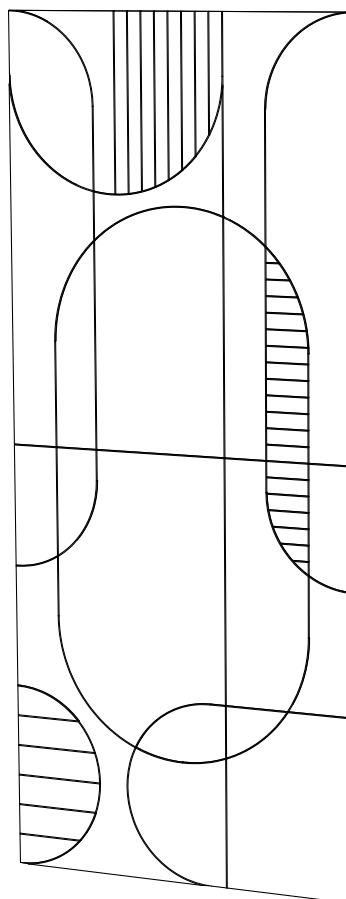
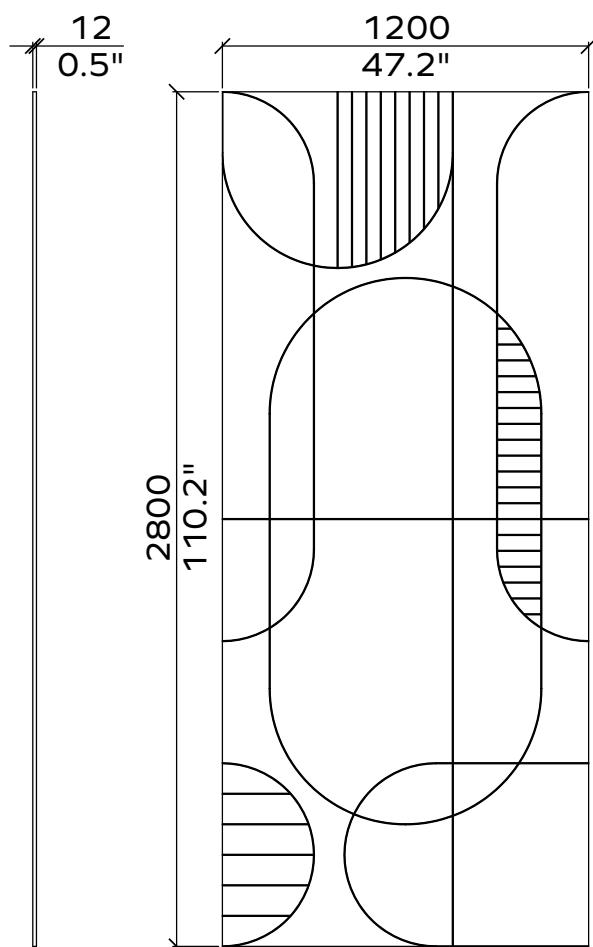
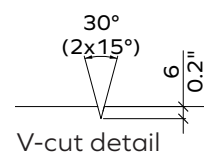















all dimensions are nominal

# ARCHISONIC®









## Colors

 Material brochure available

								
<b>Name</b>	Snow White	Milk	Cloud	Smoke	Ground	Charcoal	Slate	Raven
<b>Color Code</b>	500	404	103	442	108	542	444	550
<b>NCS Code</b>	S 0300-N	S 0502-Y	S 1002-B	S 3005-R80B	S 5005-Y20R	S 7502-B	S 4500-N	S 8500-N

								
<b>Name</b>	Nordic Pine	Grove	Moss	Spearmint	Ice Blue	Succulent	Deep Sea	Marine Blue
<b>Color Code</b>	311	317	439	706	304	712	918	864
<b>NCS Code</b>	S 5030-G10Y	S 7020-G30Y	S 2040-G40Y	S 1010-B90G	S 0510-B	S 3020-B30G	S 5020-R90B	S 4050-R70B

								
<b>Name</b>	Linen	Shell Pink	Jute	Warm Stone	Terracotta	Soft Coral	Honeycomb	Sunshine
<b>Color Code</b>	107	102	920	105	239	516	139	846
<b>NCS Code</b>	S 1505-Y30R	S 0510-R30B	S 3010-Y30R	S 3010-Y50R	S 4040-Y70R	S 2020-Y90R	S 2050-Y20R	S 1040-Y10R

								
<b>Name</b>	Garnet	Hot Pink	Poster Red	Electric Orange	Winter Sky	Pacific Ocean	Midnight	Grape
<b>Color Code</b>	724	140	662	464	311	311	810	540
<b>NCS Code</b>	S 5040-R10B	S 2060-R20B	S 1080-R	S 0580-Y70R	S 5030-G10Y	S 5030-G10Y	S 7020-R70B	S 5040-R40B

These NCS codes are the closest visual match available and may not be exact to blended fibres.

**ARCHISONIC®**

## Colors

Experience our ARCHISONIC® Felt material with a stunning selection of 32 colors across 8 distinct families, thoughtfully curated by *Colour Hive* in London. Effortlessly combine colors harmoniously to suit your preferences. Discover more in our Materials brochure and order your free sample box today.

## Color fastness

Class 6

ISO 105-B02:A1

## Order a free sample box





# ARCHISONIC®

## Material Specification

<b>Product Name</b>	Archisonic® Felt	
<b>Content</b>	100% PET (60% certified post-consumer content)	
<b>Thickness<sup>1</sup></b>	12mm (0.47")	24mm (0.94")
<b>Max. Size</b>	1200x2800mm (47"x110")	1800x2400mm (70"x94")
<b>Acoustic<sup>2</sup></b>	<b>ASTM:</b> NRC=0.6 <b>ISO:</b> αw=0.65	<b>ASTM:</b> NRC=0.9 <b>ISO:</b> αw=0.95
<b>Density<sup>1</sup></b>	2400 g/m <sup>2</sup> (0.49 lbs/ sqft)	4000 g/m <sup>2</sup> (0.82 lbs/sqft)
<b>Color Fastness</b>	<b>Class 6</b> ISO 105-B02:A1	
<b>Color</b>	<b>32 colors</b> (see Archisonic® Felt Color page for more information)	
<b>Maintenance</b>	For daily cleaning we recommend alcohol solution (75%), e.g. Pantasept. In case of contamination by dust or fluff, use feather duster or a regular vacuum cleaner. For heavy dirt, treat the material with hydrogen peroxide.	
<b>Lead time<sup>3</sup></b>	21 days	
<b>Fire Rating</b>	DIN EN 13501-1: <b>B-s1, d0</b>	ASTM E84 <b>Class A</b>
<b>VOC Emission</b>	<b>A+</b> 28 Days French Regulation	ASTM E84 <b>Pass</b>
<b>Certifications</b>	Declare label, Cradle to Cradle, UL Environmental Product Declaration, Member of US Green Building Council, Ecobau 1st Priority, Climmate-KIC, VOC emissions in LEED EQ credit (low-emitting products), Bream, SCS Recycled Content	
<b>Durability</b>	Contract	

1 - all values are nominal 2 - measured with 300mm air cavity 3 - depending on the location and type of product



Climate-KIC is supported by the EIT, a body of the European Union



**Declare.**





# Vela

## Acoustic Performance

### ISO Standards

ISO 354:2003	Acoustics — Measurement of sound absorption in a reverberation room
ISO 11654:1997	Acoustics — Sound absorbers for use in buildings — Rating of sound absorption
ISO 20189:2018	Acoustics — Screens, furniture and single objects intended for interior use — Rating of sound absorption and sound reduction of elements based on laboratory measurements

### Equivalent ASTM Standards

ASTM C423-17	Standard Test Method for Sound Absorption and Sound Absorption Coefficients by the Reverberation Room Method
ASTM E795-16	Standard Practices for Mounting Test Specimens During Sound Absorption Tests

### Acoustic Test Results ISO

Frequency (Hz)		125	250	500	1000	2000	4000	$\alpha_w$
Archisonic 12mm (no air gap)	m <sup>2</sup>	0.05	0.05	0.25	0.55	0.85	1.05	0.30 (MH)
Archisonic 12mm (50mm air gap)	m <sup>2</sup>	0.05	0.15	0.45	0.80	0.80	0.75	0.50
Archisonic 12mm (50mm insulation)	m <sup>2</sup>	0.35	0.85	1.00	1.00	1.00	1.00	1.00
Archisonic 24mm (no air gap)	m <sup>2</sup>	0.05	0.25	0.55	1.05	1.05	1.10	0.55 (MH)
Archisonic 24mm (50mm air gap)	m <sup>2</sup>	0.15	0.35	0.75	1.00	1.00	1.05	0.65 (MH)
Archisonic 24mm (50mm insulation)	m <sup>2</sup>	0.40	0.90	1.00	1.00	1.00	1.00	1.00

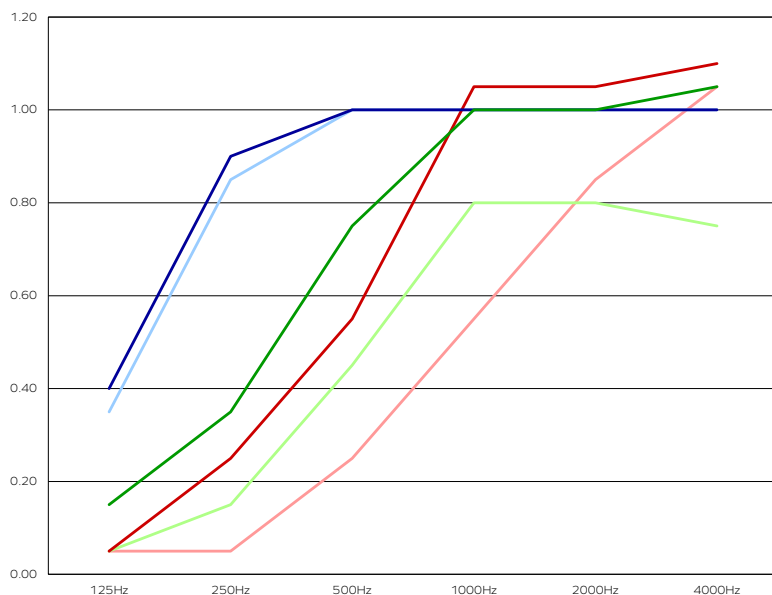

*“It’s all about mass, depth and density when considering wall panels, the more surface you cover the more you can absorb. It’s not recommended to hang a wall panel on your colleague and turn him into a walking billboard as he won’t absorb your sense of humour.”*

– Daniel Verlooven,  
Global Acoustic Ambassador

- Wallcovering 12mm (no air gap)
- Wallcovering 24mm (no air gap)
- Wallcovering 12mm (50mm cavity)
- Wallcovering 24mm (50mm cavity)
- Wallcovering 12mm (50mm insulation)
- Wallcovering 24mm (50mm insulation)

The graph represents the sound absorption coefficients ( $\alpha_s$ ) in the third octave band center frequencies. Measurement used Pink Noise as excitation signal in a reverberant room.

### Acoustic Test Results ASTM NRC

Archisonic 12mm (no air gap)	0.45
Archisonic 12mm (50mm air gap)	0.55
Archisonic 12mm (50mm insulation)	0.95
Archisonic 24mm (no air gap)	0.70
Archisonic 24mm (50mm air gap)	0.80
Archisonic 24mm (50mm insulation)	1.00





# Wall Covering

## Reference Projects

